

# TEHNIČKI LIST

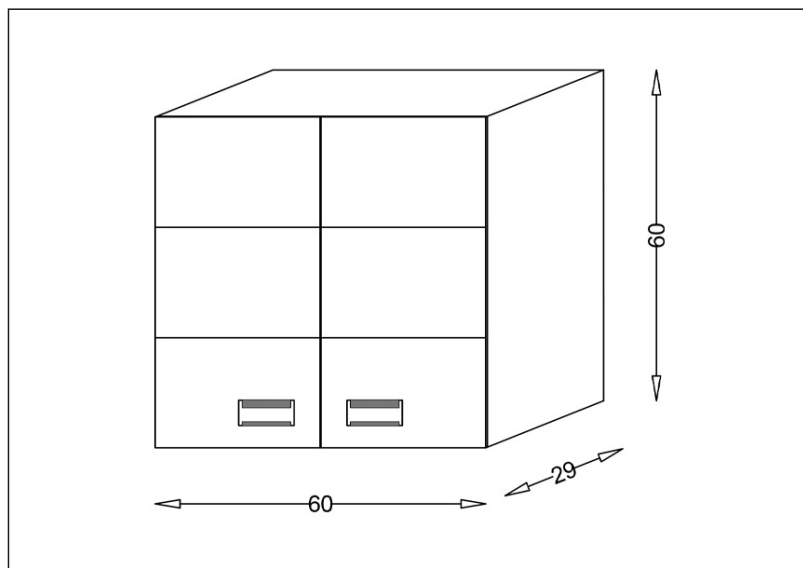

Seriya: **VIENNA**

Šifra proizvoda: **26500120**

## TEHNIČKI PODACI

Težina: 15,000Kg

Materijal: Medijapan

Dimenzije: 60x60x29cm

Proizvođač: Stojković Keramika d.o.o.

Zemlja proizvodnje: Srbija