

**PREINSTALLATION  
VORINSTALLATION**

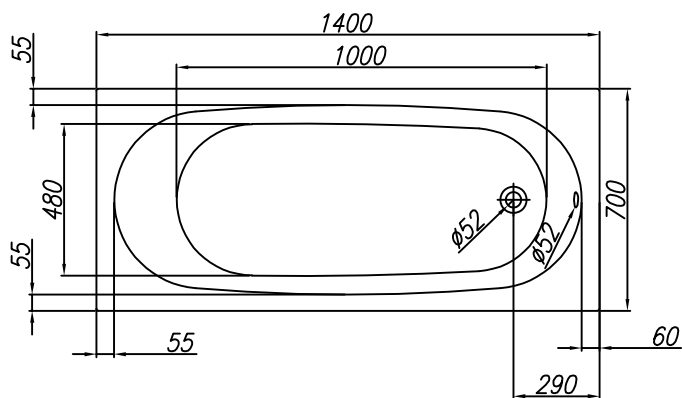
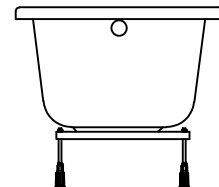
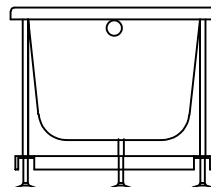
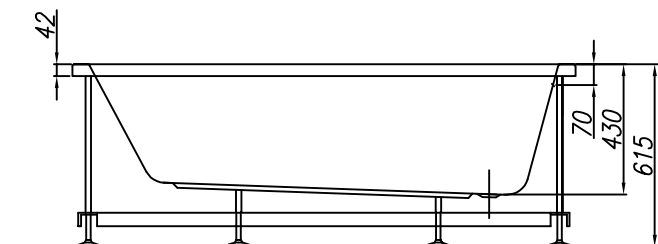
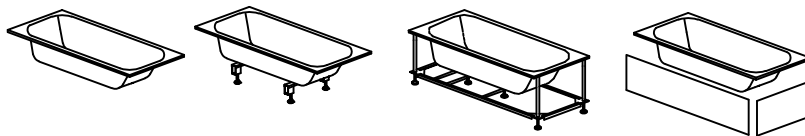

VOLUME (l)  
VOLUMEN (l)

MAX. LOAD (kg)  
MAX. BELASTUNG (kg)

FLOOR LOAD (kg/m<sup>2</sup>)  
BODENBELASTUNG (kg/m<sup>2</sup>)

155

290

295

- - Drain spot Ø 50mm  
- Abflussplatz Ø 50 mm
- ▣ - Panel - option  
- Möglichkeit - Schürze

**INSTALLATION RECOMMENDATION  
MONTAGEEMPFEHLUNG**

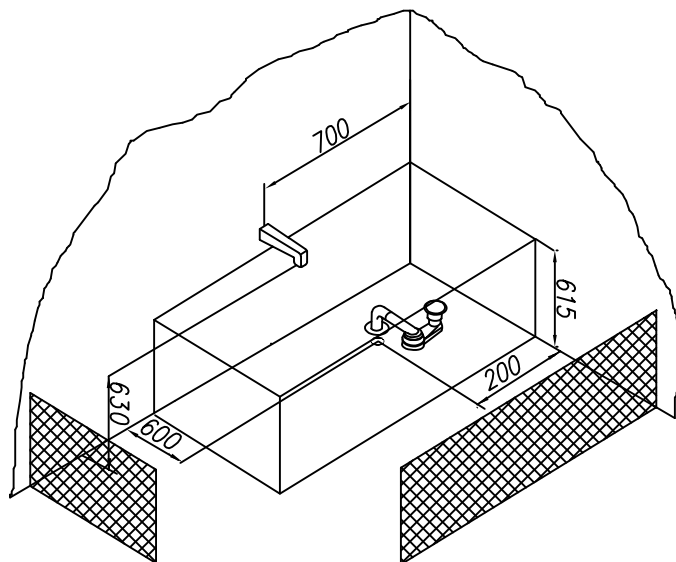

Recommended overflow set Vorgeschlagene Überlaufgarnitur	PAL 450
Recommendations for the installation of bathtub without panel Empfehlungen für die Montage von Badewannen ohne Schürze	Nr. MK 03
Recommendations for the installation of bathtub with panel Empfehlungen für die Montage von Badewannen mit Schürze	Nr. MK 01
Option of the built-in bathtub base Möglichkeit des Sockels für die Badewannen ohne Schürze	Nr. MK 05 PKK 501
Option of the bathtub base with panel Möglichkeit des Sockels für die Badewannen mit Schürze	Nr. MK 20 Set EAN code

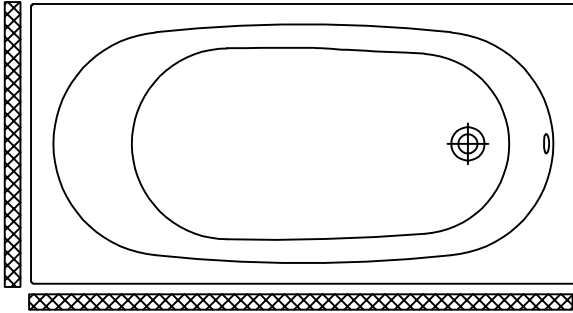

- OPTION PANEL FOR BATHTUB      - OPTION SHÜRZE FÜR BADEWANNE

