

PREINSTALLATION  
VORINSTALLATION

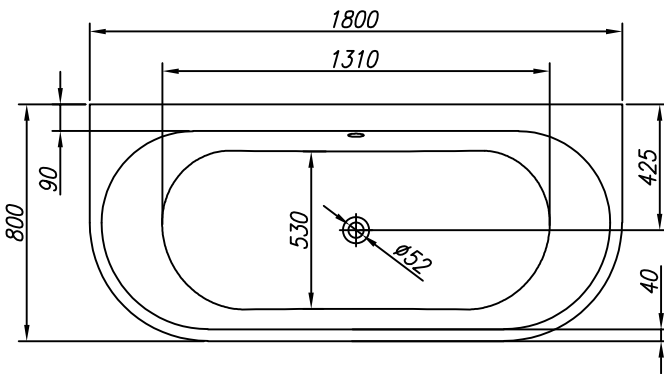
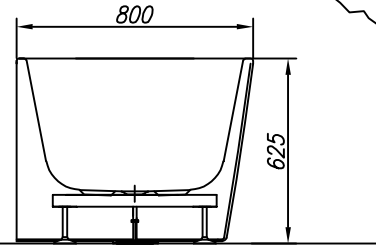
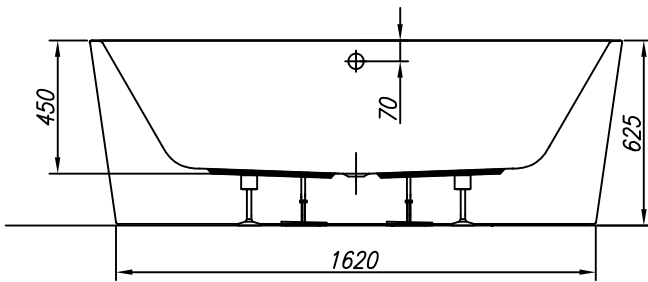
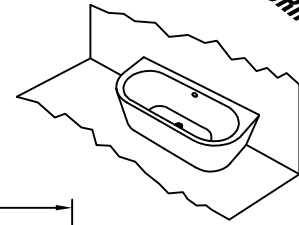

VOLUME (l)  
VOLUMEN (l)

MAX. LOAD (kg)  
MAX. BELASTUNG (kg)

FLOOR LOAD (kg/m<sup>2</sup>)  
BODENBELASTUNG (kg/m<sup>2</sup>)

245

400

280

- - Spot for el. cable 3×2.5mm<sup>2</sup>, length approx. 1m
- Platz Stromkabel 3 × 2,5 mm<sup>2</sup>, Länge cca. 1 m
- - Spot for el. cable 1×6mm<sup>2</sup> for earthing, length approx. 1.5m
- Platz Stromkabel 1 × 6 mm<sup>2</sup> für Erdung, Länge cca. 1,5 m



- Connection of hot and cold water 1/2" min 0.2Mpa, max 0.4Mpa
- Anschluss Warm- und Kaltwasser 1/2" min 0,2 Mpa, max 0,4 Mpa



- Drain spot Ø 50mm
- Abflussplatz Ø 50 mm

INSTALLATION RECOMMENDATION  
MONTAGEEMPFEHLUNG

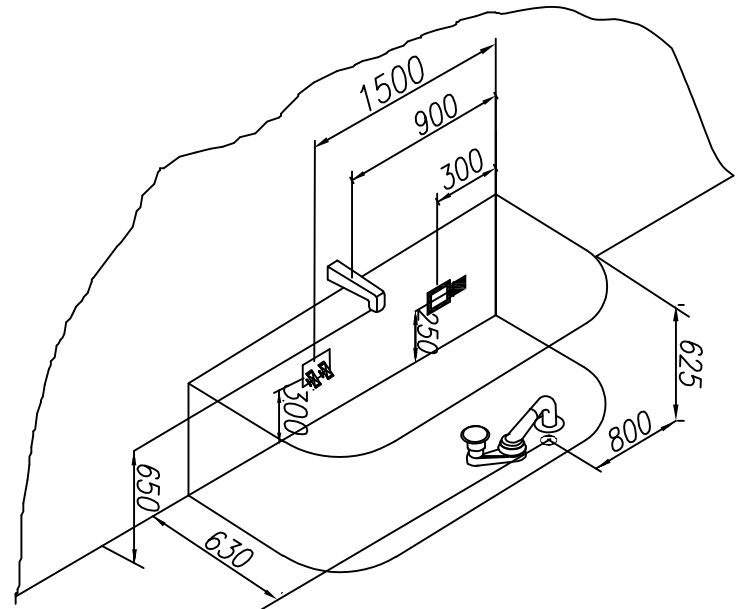

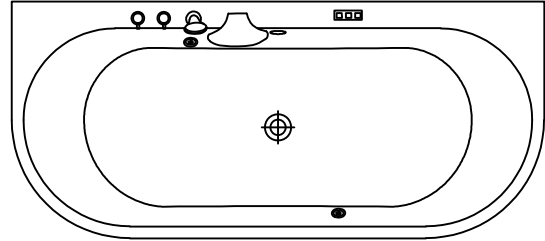
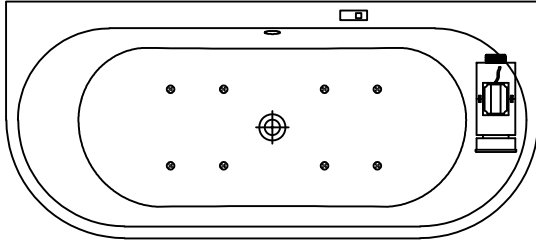
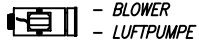
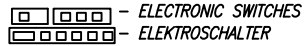
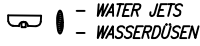
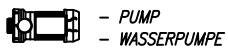

AIR MASSAGE SYSTEM

- BLOWER P=800W
- ELECTRONIC SWITCH
- 8 AIR JETS

LUFT MASSAGESYSTEM

- LUFTPUMPE P = 800 W
- ELEKTROSCHALTER
- 8 LUFTDÜSEN

- OPTION FIXTURE AND SHOWER HANDLE
- MÖGLICHKEIT WASSERHAHN UND DUSCHE

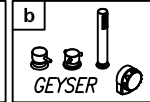
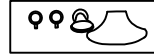

- OPTION CHROMOTHERAPY

- MÖGLICHKEIT CHROMOTHERAPIE

