

PREINSTALLATION
VORINSTALLATION

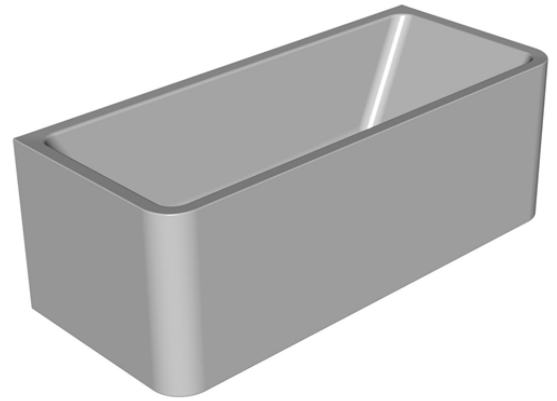

VOLUME (l)
VOLUMEN (l)

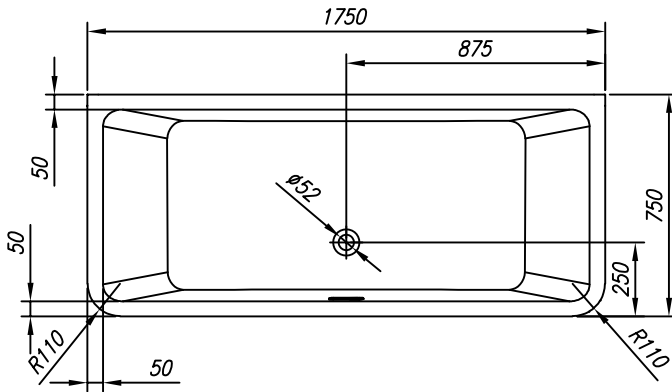

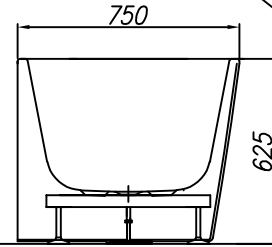
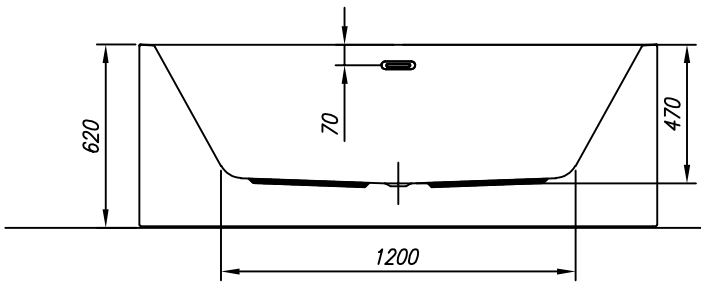





MAX. LOAD (kg)
MAX. BELASTUNG (kg)

FLOOR LOAD (kg/m²)
BODENBELASTUNG (kg/m²)

265

405

310

-  - Spot for el. cable 3×2.5mm², length approx. 1m
-  - Platz Stromkabel 3 × 2,5 mm², Länge cca. 1 m
-  - Spot for el. cable 1×6mm² for earthing, length approx. 1.5m
-  - Platz Stromkabel 1 × 6 mm² für Erdung, Länge cca. 1,5 m
-  - Connection of hot and cold water 1/2" min 0.2Mpa, max 0.4Mpa
-  - Anschluss Warm- und Kaltwasser 1/2" min 0,2 Mpa, max 0,4 Mpa
-  - Drain spot Ø 50mm
-  - Abflussplatz Ø 50 mm

INSTALLATION RECOMMENDATION
MONTAGEEMPFEHLUNG

